

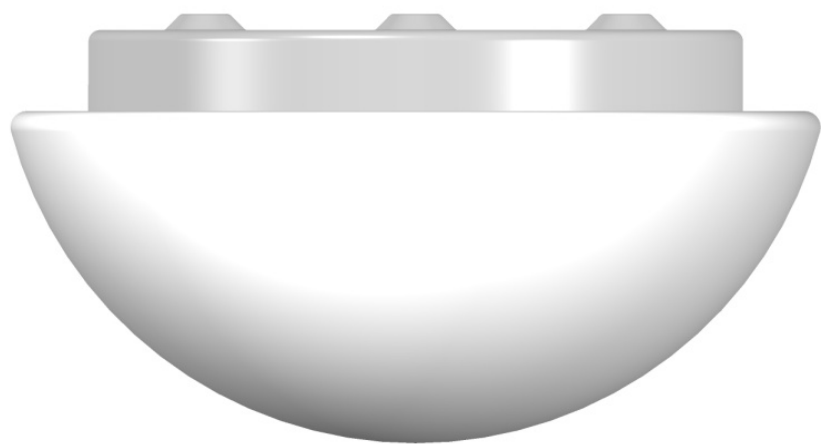

2018

GLANUR Opalglasleuchten



METAJ

Opalglasleuchte GLANUR 190x190 S (E27 Fassung, LED)

Ausführung opal glänzend oder matt, Unterteil weiß, Stahl oder Aluminium (LED), mundgeblasenes Dreischichtglas Triplex mit sehr guter blendfreier Lichtverteilung, einfache und schnelle Montage mit Klappverschluß, starke Federn für sicheren Halt, für Wand- /Deckenmontage geeignet. Die IP44 Leuchte ist auch als Hausnummernleuchte geeignet.



| Opal glanz B. Nr. | Opal matt B. Nr. | Bestückung | Leistung | Montage | | Sensor | Eulum data | ENEC |
|--------------------------|------------------|------------|----------|---------|------|--------|------------|------|
| | | | | Decke | Wand | | | |
| E27 LEUCHTEN IP40 | | | | | | | | |
| 12240 | 12241 | 1xE27 | 60W | • | • | | | • |
| E27 LEUCHTEN IP44 | | | | | | | | |
| 30104 | 30105 | 1xE27 | 60W | • | • | | | |



| Opal glanz B. Nr. | Opal matt B. Nr. | Bestückung | Leistung | Montage | | Lumens /Lichtfarbe | | | Sensor | Eulum data | ENEC | Dim |
|--------------------------|------------------|------------|----------|---------|------|--------------------|-------|-------|--------|------------|------|-----|
| | | | | Decke | Wand | 3000K | 4000K | 5600K | | | | |
| LED LEUCHTEN IP40 | | | | | | | | | | | | |
| 50100 | 50101 | AC LED | 4W | • | • | 260 | | 360 | | | | |
| 50120 | 50121 | AC LED | 9W | • | • | 715 | 750 | | | | | |
| 50130 | 50131 | AC LED | 13W | • | • | 1130 | 1350 | 1350 | | | | • |
| LED LEUCHTEN IP44 | | | | | | | | | | | | |
| 50104 | 50105 | AC LED | 4W | • | • | 260 | | 360 | | | | |
| 50124 | 50125 | AC LED | 9W | • | • | 715 | 750 | | | | | |
| 50134 | 50135 | AC LED | 13W | • | • | 1130 | 1350 | 1350 | | | | • |

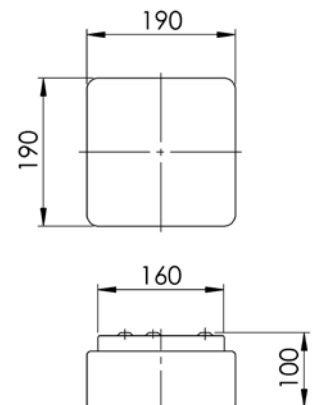

Opalglasleuchte GLANUR 200 S (E27 Fassung, LED)

Ausführung opal glänzend oder matt, Unterteil weiß, Stahl oder Aluminium (LED), mundgeblasenes Dreischichtglas Triplex mit sehr guter blendfreier Lichtverteilung, einfache und schnelle Montage mit Klappverschluß, starke Federn für sicheren Halt, für Wand- /Deckenmontage geeignet



| Opal glanz B. Nr. | Opal matt B. Nr. | Bestückung | Leistung | Montage | | Sensor | Eulum data | ENEC |
|--------------------------|---------------------|------------|----------|---------|------|--------|---------------|------|
| | | | | Decke | Wand | | | |
| E27 LEUCHTEN IP40 | | | | | | | | |
| 10410 | 10411 | 1xE27 | 60W | • | • | | | • |
| E27 LEUCHTEN IP44 | | | | | | | | |
| 30204 | 30205 | 1xE27 | 60W | • | • | | | |



| Opal glanz B. Nr. | Opal matt B. Nr. | Bestückung | Leistung | Montage | | Lumens /Lichtfarbe | | | Sensor | Eulum data | ENEC | Dim |
|--------------------------|---------------------|------------|----------|---------|------|--------------------|-------|-------|--------|---------------|------|-----|
| | | | | Decke | Wand | 3000K | 4000K | 5600K | | | | |
| LED LEUCHTEN IP40 | | | | | | | | | | | | |
| 50210 | 50211 | AC LED | 9W | • | • | 715 | 750 | | | | | |
| 50220 | 50221 | AC LED | 13W | • | • | 1130 | 1350 | 1350 | | | | • |
| LED LEUCHTEN IP44 | | | | | | | | | | | | |
| 50214 | 50215 | AC LED | 9W | • | • | 715 | 750 | | | | | |
| 50224 | 50225 | AC LED | 13W | • | • | 1130 | 1350 | 1350 | | | | • |

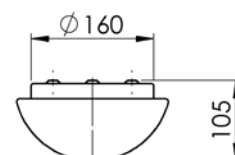
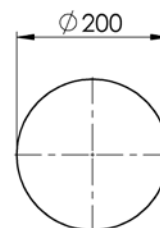

Opalglasleuchte GLANUR 240x240 S (E27 Fassung, LED)

Ausführung opal glänzend oder matt, Unterteil weiß, Stahl oder Aluminium (LED), mundgeblasenes Dreischichtglas Triplex mit sehr guter blendfreier Lichtverteilung, einfache und schnelle Montage mit Klappverschluß, starke Federn für sicheren Halt, für Wand- und Deckenmontage geeignet, LED-Leuchten auch mit Bewegungssensor (BS) ausstattbar. Die IP44 Leuchte ist auch als Hausnummernleuchte geeignet und kann mit Dämmerungsschalter (DS) ausgestattet sein. Zu dieser Leuchte passt auch ein frei untergesetzter Dekorrand aus Metall (weiß, schwarz, grau).



| Opal glanz B. Nr. | Opal matt B. Nr. | Bestückung | Leistung | Montage | | Sensor | Eulum data | ENEC |
|--------------------------|---------------------|------------|----------|---------|------|--------|---------------|------|
| | | | | Decke | Wand | | | |
| E27 LEUCHTEN IP40 | | | | | | | | |
| 12250 | 12251 | 1xE27 | 60W | • | • | | | • |
| E27 LEUCHTEN IP44 | | | | | | | | |
| 31104 | 31105 | 1xE27 | 60W | • | • | | | |



| Opal glanz B. Nr. | Opal matt B. Nr. | Bestückung | Leistung | Montage | | Lumens /Lichtfarbe | | | Sensor | Eulum data | ENEC | Dim |
|--------------------------|---------------------|------------|----------|---------|------|--------------------|-------|-------|--------|---------------|------|-----|
| | | | | Decke | Wand | 3000K | 4000K | 5600K | | | | |
| LED LEUCHTEN IP40 | | | | | | | | | | | | |
| 51100 | 51101 | AC LED | 4W | • | • | 260 | | 360 | | | | |
| 51102 | 51103 | AC LED | 4W | • | • | 260 | | 360 | BS | | | |
| 51120 | 51121 | AC LED | 9W | • | • | 715 | 750 | | | • | | |
| 51122 | 51123 | AC LED | 9W | • | • | 715 | 750 | | BS | • | | |
| 13241 | 13242 | AC LED | 12W | • | • | 780 | | 1080 | | | | |
| 51170 | 51171 | AC LED | 12W | • | • | 1120 | 1200 | | | • | | |
| 51172 | 51173 | AC LED | 12W | • | • | 1120 | 1200 | | BS | • | | |
| 51130 | 51131 | AC LED | 13W | • | • | 1130 | 1350 | 1350 | | • | | • |
| 51132 | 51133 | AC LED | 13W | • | • | 1130 | 1350 | 1350 | BS | • | | • |
| 15596 | 15597 | AC LED | 16W | • | • | 1040 | | 1440 | | | | |
| 51140 | 51141 | AC LED | 17W | • | • | 1500 | 1700 | 1700 | | • | | • |
| LED LEUCHTEN IP44 | | | | | | | | | | | | |
| 51104 | 51105 | AC LED | 4W | • | • | 260 | | 360 | | | | |
| 51106 | 51107 | AC LED | 4W | • | • | 260 | | 360 | BS | | | |
| 51108 | 51109 | AC LED | 4W | • | • | 260 | | 360 | DS | | | |
| 51124 | 51125 | AC LED | 9W | • | • | 750 | 750 | | | • | | |
| 51126 | 51127 | AC LED | 9W | • | • | 750 | 750 | | BS | • | | |
| 51174 | 51175 | AC LED | 12W | • | • | 1120 | 1200 | | | • | | |
| 51176 | 51177 | AC LED | 12W | • | • | 1120 | 1200 | | BS | • | | |
| 51134 | 51135 | AC LED | 13W | • | • | 1130 | 1350 | 1350 | | • | | • |
| 51136 | 51137 | AC LED | 13W | • | • | 1130 | 1350 | 1350 | BS | • | | • |
| 51144 | 51145 | AC LED | 17W | • | • | 1500 | 1700 | 1700 | | • | | • |

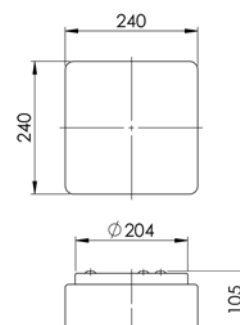

Opalglasleuchte GLANUR 240x240 SN (E27 Fassung, LED)

Ausführung opal glänzend oder matt, Unterteil weiß, Stahl oder Aluminium (LED), mundgeblasenes Dreischichtglas Triplex mit sehr guter blendfreier Lichtverteilung, einfache und schnelle Montage mit Klappverschluß, starke Federn für sicheren Halt, für Wand- /Deckenmontage geeignet, LED-Leuchten auch mit Bewegungssensor ausstattbar



| Opal glanz B. Nr. | Opal matt B. Nr. | Bestückung | Leistung | Montage | | Sensor | Eulum data | ENEC |
|--------------------------|---------------------|------------|----------|---------|------|--------|---------------|------|
| | | | | Decke | Wand | | | |
| E27 LEUCHTEN IP40 | | | | | | | | |
| 15750 | 15751 | 1xE27 | 60W | • | • | | | • |
| E27 LEUCHTEN IP44 | | | | | | | | |
| 31204 | 31205 | 1xE27 | 60W | • | • | | | |



| Opal glanz B. Nr. | Opal matt B. Nr. | Bestückung | Leistung | Montage | | Lumens /Lichtfarbe | | | Sensor | Eulum data | ENEC | Dim |
|--------------------------|---------------------|------------|----------|---------|------|--------------------|-------|-------|--------|---------------|------|-----|
| | | | | Decke | Wand | 3000K | 4000K | 5600K | | | | |
| LED LEUCHTEN IP40 | | | | | | | | | | | | |
| 51210 | 51211 | AC LED | 9W | • | • | 715 | 750 | | | • | | |
| 51212 | 51213 | AC LED | 9W | • | • | 715 | 750 | | • | • | | |
| 15790 | 15791 | AC LED | 12W | • | • | 780 | | 1080 | | • | | |
| 51260 | 51261 | AC LED | 12W | • | • | 1120 | 1200 | | | • | | |
| 51262 | 51263 | AC LED | 12W | • | • | 1120 | 1200 | | • | • | | |
| 51220 | 51221 | AC LED | 13W | • | • | 1130 | 1350 | 1350 | | • | | • |
| 51222 | 51223 | AC LED | 13W | • | • | 1130 | 1350 | 1350 | • | • | | • |
| 15792 | 15793 | AC LED | 16W | • | • | 1040 | | 1440 | | • | | |
| 51230 | 51231 | AC LED | 17W | • | • | 1500 | 1700 | 1700 | | • | | • |
| LED LEUCHTEN IP44 | | | | | | | | | | | | |
| 51214 | 51215 | AC LED | 9W | • | • | 715 | 750 | | | • | | |
| 51216 | 51217 | AC LED | 9W | • | • | 715 | 750 | | • | • | | |
| 51264 | 51265 | AC LED | 12W | • | • | 1120 | 1200 | | | • | | |
| 51266 | 51267 | AC LED | 12W | • | • | 1120 | 1200 | | • | • | | |
| 51224 | 51225 | AC LED | 13W | • | • | 1130 | 1350 | 1350 | | • | | • |
| 51226 | 51227 | AC LED | 13W | • | • | 1130 | 1350 | 1350 | • | • | | • |
| 51234 | 51235 | AC LED | 17W | • | • | 1500 | 1700 | 1700 | | • | | • |

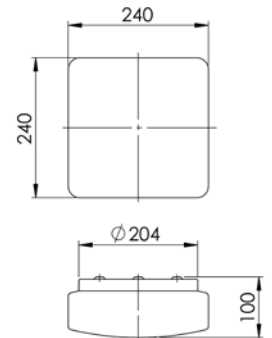

Opalglasleuchte GLANUR 260 S (E27 Fassung, LED)

Ausführung opal glänzend oder matt, Unterteil weiß, Stahl oder Aluminium (LED), mundgeblasenes Dreischichtglas Triplex mit sehr guter blendfreier Lichtverteilung, einfache und schnelle Montage mit Klappverschluß, starke Federn für sicheren Halt, für Wand- /Deckenmontage geeignet



| Opal glanz B. Nr. | Opal matt B. Nr. | Bestückung | Leistung | Montage | | Sensor | Eulum data | ENEC |
|--------------------------|---------------------|------------|----------|---------|------|--------|---------------|------|
| | | | | Decke | Wand | | | |
| E27 LEUCHTEN IP40 | | | | | | | | |
| 10340 | 10341 | 1xE27 | 60W | • | • | | | • |
| E27 LEUCHTEN IP44 | | | | | | | | |
| 31304 | 31304 | 1xE27 | 60W | • | • | | | |



| Opal glänzend B. Nr. | Opal matt B. Nr. | Bestückung | Leistung | Montage | | Lumens /Lichtfarbe | | | Sensor | Eulum data | ENEC | Dim |
|----------------------------|---------------------|------------|----------|---------|------|--------------------|-------|-------|--------|---------------|------|-----|
| | | | | Decke | Wand | 3000K | 4000K | 5600K | | | | |
| LED LEUCHTEN IP40 | | | | | | | | | | | | |
| 51310 | 51311 | AC LED | 9W | • | • | 715 | 750 | | | • | | |
| 13193 | 13194 | AC LED | 12W | • | • | 780 | | 1080 | | • | | |
| 51360 | 51361 | AC LED | 12W | • | • | 1120 | 1200 | | | • | | |
| 51320 | 51321 | AC LED | 13W | • | • | 1130 | 1350 | 1350 | | • | | • |
| 51322 | 51323 | AC LED | 13W | • | • | 1130 | 1350 | 1350 | • | • | | • |
| 15590 | 15591 | AC LED | 16W | • | • | 1040 | | 1440 | | | | |
| 51330 | 51331 | AC LED | 17W | • | • | 1500 | 1700 | 1700 | | • | | • |
| LED LEUCHTEN IP44 | | | | | | | | | | | | |
| 51314 | 51315 | AC LED | 9W | • | • | 715 | 750 | | | • | | |
| 51364 | 51365 | AC LED | 12W | • | • | 1120 | 1200 | | | • | | |
| 51324 | 51325 | AC LED | 13W | • | • | 1130 | 1350 | 1350 | | • | | • |
| 51326 | 51327 | AC LED | 13W | • | • | 1130 | 1350 | 1350 | • | • | | • |
| 51334 | 51335 | AC LED | 17W | • | • | 1500 | 1700 | 1700 | | • | | • |

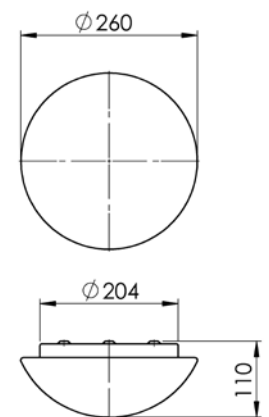

Opalglasleuchte GLANUR 260 S (E27 Fassung, LED)

Ausführung opal glänzend oder matt, Unterteil weiß, Stahl oder Aluminium, mundgeblasenes Dreischichtglas Triplex mit sehr guter blendfreier Lichtverteilung, einfache und schnelle Montage mit Klappverschluß, starke Federn für sicheren Halt, für Wand- /Deckenmontage geeignet



| Opal glanz B. Nr. | Opal matt B. Nr. | Bestückung | Leistung | Montage | | Sensor | Eulum data | ENEC |
|--------------------------|------------------|------------|----------|---------|------|--------|------------|------|
| | | | | Decke | Wand | | | |
| E27 LEUCHTEN IP40 | | | | | | | | |
| 10350 | 10351 | 1xE27 | 75W | • | • | | | • |
| E27 LEUCHTEN IP44 | | | | | | | | |
| 31404 | 31405 | 1xE27 | 60W | • | • | | | |



| Opal glanz B. Nr. | Opal matt B. Nr. | Bestückung | Leistung | Montage | | Lumens /Lichtfarbe | | | Sensor | Eulum data | ENEC | Dim |
|--------------------------|------------------|------------|----------|---------|------|--------------------|-------|-------|--------|------------|------|-----|
| | | | | Decke | Wand | 3000K | 4000K | 5600K | | | | |
| LED LEUCHTEN IP40 | | | | | | | | | | | | |
| 13196 | 13197 | AC LED | 12W | • | • | 780 | | | 1080 | | • | |
| 15593 | 15594 | AC LED | 16W | • | • | 1040 | | | 1440 | | | |

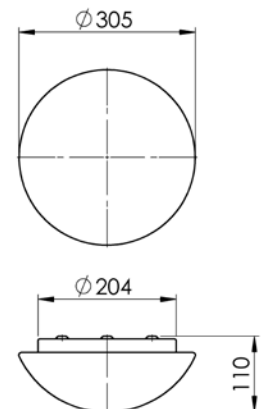

Opalglasleuchte GLANUR 310 S (E27 Fassung, Leuchtstofflampen, LED)
 Ausführung opal glänzend oder matt, Unterteil weiß, Stahl oder Aluminium (LED), mundgeblasenes Dreischichtglas Triplex mit sehr guter blendfreier Lichtverteilung, einfache und schnelle Montage mit Klappverschluß, starke Federn für sicheren Halt, für Wand- /Deckenmontage geeignet, LED Leuchten auch mit Bewegungssensor



| Opal glanz B. Nr. | Opal matt B. Nr. | Bestückung | Leistung | Montage | | Sensor | Eulum data | ENEC |
|--------------------------|------------------|------------|----------|---------|------|--------|------------|------|
| | | | | Decke | Wand | | | |
| E27 LEUCHTEN IP40 | | | | | | | | |
| 12214 | 12215 | 1xE27 | 75W | • | • | | | • |
| 12216 | 12217 | 2xE27 | 2x40W | • | • | | | |
| E27 LEUCHTEN IP44 | | | | | | | | |
| 32104 | 32105 | 1xE27 | 75W | • | • | | | |
| 32114 | 32115 | 2xE27 | 2x40W | • | • | | | |



| Opal glanz B. Nr. | Opal matt B. Nr. | Bestückung | Leistung | Montage | | Lumens /Lichtfarbe | | | Sensor | Eulum data | ENEC | Dim |
|--------------------------|------------------|------------|----------|---------|------|--------------------|-------|-------|--------|------------|------|-----|
| | | | | Decke | Wand | 3000K | 4000K | 5600K | | | | |
| LED LEUCHTEN IP40 | | | | | | | | | | | | |
| 52100 | 52101 | AC LED | 9W | • | • | 715 | 750 | | | | | |
| 52102 | 52103 | AC LED | 9W | • | • | 715 | 750 | | • | | | |
| 52160 | 52161 | AC LED | 12W | • | • | 1120 | 1200 | | | • | | |
| 52162 | 52163 | AC LED | 12W | • | • | 1120 | 1200 | | • | • | | |
| 52130 | 52131 | AC LED | 13W | • | • | 1130 | 1350 | 1350 | | • | | • |
| 52132 | 52133 | AC LED | 13W | • | • | 1130 | 1350 | 1350 | • | • | | • |
| 52150 | 52151 | AC LED | 17W | • | • | 1500 | 1700 | 1700 | | • | | • |
| 52152 | 52153 | AC LED | 17W | • | • | 1500 | 1700 | 1700 | • | • | | • |
| 52140 | 52141 | AC LED | 26W | • | • | 2260 | 2700 | 2700 | | • | | • |
| 52142 | 52143 | AC LED | 26W | • | • | 2260 | 2700 | 2700 | • | • | | • |
| LED LEUCHTEN IP44 | | | | | | | | | | | | |
| 52104 | 52105 | AC LED | 9W | • | • | 715 | 750 | | | | | |
| 52106 | 52107 | AC LED | 9W | • | • | 715 | 750 | | • | | | |
| 52164 | 52165 | AC LED | 12W | • | • | 1120 | 1200 | | | • | | |
| 52166 | 52167 | AC LED | 12W | • | • | 1120 | 1200 | | • | • | | |
| 52134 | 52135 | AC LED | 13W | • | • | 1130 | 1350 | 1350 | | • | | • |
| 52136 | 52137 | AC LED | 13W | • | • | 1130 | 1350 | 1350 | • | • | | • |
| 52154 | 52155 | AC LED | 17W | • | • | 1500 | 1700 | 1700 | | • | | • |
| 52156 | 52157 | AC LED | 17W | • | • | 1500 | 1700 | 1700 | • | • | | • |
| 52144 | 52145 | AC LED | 26W | • | • | 2260 | 2700 | 2700 | | • | | • |
| 52146 | 52147 | AC LED | 26W | • | • | 2260 | 2700 | 2700 | • | • | | • |

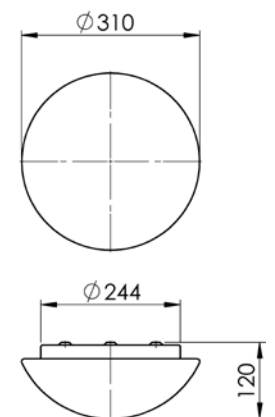

Opalglasleuchte GLANUR 310 S (E27 Fassung, Leuchtstofflampen, LED)
 Ausführung opal glänzend oder matt, Unterteil weiß, Stahl oder Aluminium (LED), mundgeblasenes Dreischichtglas Triplex mit sehr guter blendfreier Lichtverteilung, einfache und schnelle Montage mit Klappverschluss, starke Federn für sicheren Halt, für Wand- /Deckenmontage geeignet, LED Leuchten auch mit Bewegungssensor



| Opal glanz B. Nr. | Opal matt B. Nr. | Typ | Leistung | Bestückung í | Montage | | Sensor | Eulum data | ENEC |
|-------------------------------------|------------------|-----|----------|--------------|---------|------|--------|------------|------|
| | | | | | Decke | Wand | | | |
| LEUCHTSTOFFLAMPEN IP41 | | | | | | | | | |
| 12575 | 12576 | EVG | 13W | 1xG24q1 | • | • | | | • |
| 12722 | 12723 | EVG | 18W | 1xG24q2 | • | • | | • | • |
| 12732 | 12733 | EVG | 26W | 1xG24q3 | • | • | | • | • |
| 12740 | 12741 | EVG | 2x13W | 2xG24q1 | • | • | | | • |
| 12750 | 12751 | EVG | 2x18W | 2xG24q2 | • | • | | • | • |
| 12760 | 12761 | EVG | 2x26W | 2xG24q3 | • | • | | • | • |
| LEUCHTSTOFFLAMPEN IP44 | | | | | | | | | |
| 42104 | 42105 | EVG | 13W | 1xG24q1 | • | • | | | |
| 42124 | 42125 | EVG | 18W | 1xG24q2 | • | • | | • | |
| 42144 | 42145 | EVG | 26W | 1xG24q3 | • | • | | • | |
| 42114 | 42115 | EVG | 2x13W | 2xG24q1 | • | • | | | |
| 42134 | 42135 | EVG | 2x18W | 2xG24q2 | • | • | | • | |
| 42154 | 42155 | EVG | 2x26W | 2xG24q3 | • | • | | • | |
| LEUCHTSTOFFLAMPEN IP44 DECKE | | | | | | | | | |
| 14200 | 14201 | EVG | 13W | 1xG24q1 | • | | | | • |
| 14210 | 14211 | EVG | 18W | 1xG24q2 | • | | | • | • |
| 14220 | 14221 | EVG | 26W | 1xG24q3 | • | | | • | • |
| 14230 | 14231 | EVG | 2x13W | 2xG24q1 | • | | | | • |
| 14240 | 14241 | EVG | 2x18W | 2xG24q2 | • | | | • | • |
| 14250 | 14251 | EVG | 2x26W | 2xG24q3 | • | | | • | • |
| LEUCHTSTOFFLAMPEN IP44 WAND | | | | | | | | | |
| 14205 | 14206 | EVG | 13W | 1xG24q1 | | • | | | • |
| 14215 | 14216 | EVG | 18W | 1xG24q2 | | • | | • | • |
| 14225 | 14226 | EVG | 26W | 1xG24q3 | | • | | • | • |
| 14235 | 14236 | EVG | 2x13W | 2xG24q1 | | • | | | • |
| 14245 | 14246 | EVG | 2x18W | 2xG24q2 | | • | | • | • |
| 14255 | 14256 | EVG | 2x26W | 2xG24q3 | | • | | • | • |

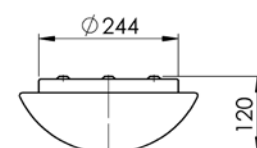
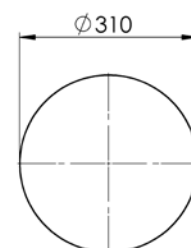

Opalglasleuchte GLANUR 365 S (E27 Fassung, Leuchtstofflampen, LED)
 Ausführung opal glänzend oder matt, Unterteil weiß, Stahl oder Aluminium (LED), mundgeblasenes Dreischichtglas Triplex mit sehr guter blendfreier Lichtverteilung, einfache und schnelle Montage mit Klappverschluß, starke Federn für sicheren Halt, für Wand- /Deckenmontage geeignet, LED Leuchten auch mit Bewegungssensor



| Opal glanz B. Nr. | Opal matt B. Nr. | Bestückung | Leistung | Montage | | Sensor | Eulum data | ENEC |
|--------------------------|------------------|------------|----------|---------|------|--------|------------|------|
| | | | | Decke | Wand | | | |
| E27 LEUCHTEN IP40 | | | | | | | | |
| 12040 | 12041 | 1xE27 | 75W | • | • | | | • |
| 10580 | 10581 | 2xE27 | 2x60W | • | • | | | • |
| E27 LEUCHTEN IP44 | | | | | | | | |
| 32204 | 32205 | 1xE27 | 75W | • | • | | | |
| 32214 | 32215 | 2xE27 | 2x40W | • | • | | | |



| Opal glanz B. Nr. | Opal matt B. Nr. | Bestückung | Leistung | Montage | | Lumens /Lichtfarbe | | | Sensor | Eulum data | ENEC | Dim |
|--------------------------|------------------|------------|----------|---------|------|--------------------|-------|-------|--------|------------|------|-----|
| | | | | Decke | Wand | 3000K | 4000K | 5600K | | | | |
| LED LEUCHTEN IP40 | | | | | | | | | | | | |
| 52240 | 52241 | AC LED | 17W | • | • | 1500 | 1700 | 1700 | | • | | • |
| 52242 | 52243 | AC LED | 17W | • | • | 1500 | 1700 | 1700 | • | • | | • |
| LED LEUCHTEN IP44 | | | | | | | | | | | | |
| 52244 | 52245 | AC LED | 17W | • | • | 1500 | 1700 | 1700 | | | | • |
| 52246 | 52247 | AC LED | 17W | • | • | 1500 | 1700 | 1700 | • | • | | • |

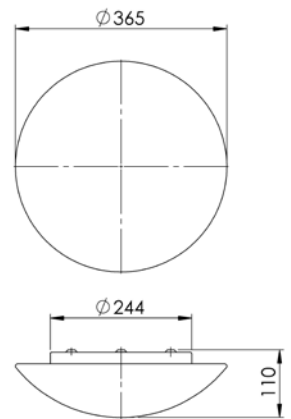

Opalglasleuchte GLANUR 365 S (E27 Fassung, Leuchtstofflampen, LED)
 Ausführung opal glänzend oder matt, Unterteil weiß, Stahl oder Aluminium (LED), mundgeblasenes Dreischichtglas Triplex mit sehr guter blendfreier Lichtverteilung, einfache und schnelle Montage mit Klappverschluss, starke Federn für sicheren Halt, für Wand- /Deckenmontage geeignet, LED Leuchten auch mit Bewegungssensor



| Opal glanz B. Nr. | Opal matt B. Nr. | Typ | Leistung | Bestückung í | Montage | | Sensor | Eulum data | ENEC |
|-------------------------------------|------------------|-----|----------|--------------|---------|------|--------|------------|------|
| | | | | | Decke | Wand | | | |
| LEUCHTSTOFFLAMPEN IP41 | | | | | | | | | |
| 12660 | 12661 | EVG | 13W | 1xG24q1 | • | • | | | • |
| 12586 | 12587 | EVG | 18W | 1xG24q2 | • | • | | • | • |
| 12588 | 12589 | EVG | 26W | 1xG24q3 | • | • | | | • |
| 12630 | 12631 | EVG | 2x13W | 2xG24q1 | • | • | | | • |
| 12032 | 12033 | EVG | 2x18W | 2xG24q2 | • | • | | • | • |
| 12034 | 12035 | EVG | 2x26W | 2xG24q3 | • | • | | • | • |
| LEUCHTSTOFFLAMPEN IP44 | | | | | | | | | |
| 42204 | 42205 | EVG | 13W | 1xG24q1 | • | • | | | |
| 42224 | 42225 | EVG | 18W | 1xG24q2 | • | • | | • | |
| 42244 | 42245 | EVG | 26W | 1xG24q3 | • | • | | | |
| 42214 | 42215 | EVG | 2x13W | 2xG24q1 | • | • | | | |
| 42234 | 42235 | EVG | 2x18W | 2xG24q2 | • | • | | • | |
| 42254 | 42255 | EVG | 2x26W | 2xG24q3 | • | • | | • | |
| LEUCHTSTOFFLAMPEN IP44 DECKE | | | | | | | | | |
| 14310 | 14311 | EVG | 13W | 1xG24q1 | • | | | | • |
| 14320 | 14321 | EVG | 18W | 1xG24q2 | • | | | • | • |
| 14330 | 14331 | EVG | 26W | 1xG24q3 | • | | | | • |
| 14340 | 14341 | EVG | 2x13W | 2xG24q1 | • | | | | • |
| 14350 | 14351 | EVG | 2x18W | 2xG24q2 | • | | | • | • |
| 14360 | 14361 | EVG | 2x26W | 2xG24q3 | • | | | • | • |
| LEUCHTSTOFFLAMPEN IP44 Wand | | | | | | | | | |
| 14315 | 14316 | EVG | 13W | 1xG24q1 | | • | | | • |
| 14325 | 14326 | EVG | 18W | 1xG24q2 | | • | | • | • |
| 14335 | 14336 | EVG | 26W | 1xG24q3 | | • | | | • |
| 14345 | 14346 | EVG | 2x13W | 2xG24q1 | | • | | | • |
| 14355 | 14356 | EVG | 2x18W | 2xG24q2 | | • | | • | • |
| 14365 | 14366 | EVG | 2x26W | 2xG24q3 | | • | | • | • |

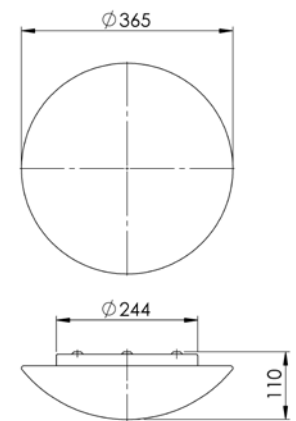

Opalglasleuchte GLANUR 365 S (E27 Fassung, Leuchtstofflampen, LED)
 Ausführung opal glänzend oder matt, Unterteil weiß, Stahl, mundgeblasenes Dreischichtglas Triplex mit
 sehr guter blendfreier Lichtverteilung, einfache und schnelle Montage mit Klappverschluss, starke Federn für
 sicheren Halt, für Wand- /Deckenmontage geeignet



| Opal glanz B. Nr. | Opal matt B. Nr. | Bestückung | Leistung | Montage | | Sensor | Eulum data | ENEC |
|--------------------------|------------------|------------|----------|---------|------|--------|------------|------|
| | | | | Decke | Wand | | | |
| E27 LEUCHTEN IP40 | | | | | | | | |
| | 12046 | 1xE27 | 75W | • | • | | | • |
| | 10591 | 2xE27 | 2x60W | • | • | | | • |
| E27 LEUCHTEN IP44 | | | | | | | | |
| | 32305 | 1xE27 | 75W | • | • | | | |
| | 32315 | 2xE27 | 2x40W | • | • | | | |



| Opal glanz B. Nr. | Opal matt B. Nr. | Typ | Leistung | Bestückung i | Montage | | Sensor | Eulum data | ENEC |
|------------------------------------|------------------|-----|----------|--------------|---------|------|--------|------------|------|
| | | | | | Decke | Wand | | | |
| LEUCHSTOFFLAMPEN IP41 | | | | | | | | | |
| | 12843 | EVG | 13W | 1xG24q1 | • | • | | | • |
| | 12593 | EVG | 18W | 1xG24q2 | • | • | | | • |
| | 12598 | EVG | 26W | 1xG24q3 | • | • | | | • |
| | 12851 | EVG | 2x13W | 2xG24q1 | • | • | | | • |
| | 12856 | EVG | 2x18W | 2xG24q2 | • | • | | | • |
| | 12861 | EVG | 2x26W | 2xG24q3 | • | • | | • | • |
| LEUCHSTOFFLAMPEN IP44 | | | | | | | | | |
| | 42305 | EVG | 13W | 1xG24q1 | • | • | | | • |
| | 42325 | EVG | 18W | 1xG24q2 | • | • | | | • |
| | 42345 | EVG | 26W | 1xG24q3 | • | • | | | • |
| | 42315 | EVG | 2x13W | 2xG24q1 | • | • | | | • |
| | 42335 | EVG | 2x18W | 2xG24q2 | • | • | | | • |
| | 42355 | EVG | 2x26W | 2xG24q3 | • | • | | • | • |
| LEUCHSTOFFLAMPEN IP44 DECKE | | | | | | | | | |
| | 14421 | EVG | 13W | 1xG24q1 | • | | | | • |
| | 14431 | EVG | 18W | 1xG24q2 | • | | | | • |
| | 14441 | EVG | 26W | 1xG24q3 | • | | | | • |
| | 14451 | EVG | 2x13W | 2xG24q1 | • | | | | • |
| | 14461 | EVG | 2x18W | 2xG24q2 | • | | | | • |
| | 14471 | EVG | 2x26W | 2xG24q3 | • | | | • | • |
| LEUCHSTOFFLAMPEN IP44 WAND | | | | | | | | | |
| | 14426 | EVG | 13W | 1xG24q1 | | • | | | • |
| | 14436 | EVG | 18W | 1xG24q2 | | • | | | • |
| | 14446 | EVG | 26W | 1xG24q3 | | • | | | • |
| | 14456 | EVG | 2x13W | 2xG24q1 | | • | | | • |
| | 14466 | EVG | 2x18W | 2xG24q2 | | • | | | • |
| | 14476 | EVG | 2x26W | 2xG24q3 | | • | | • | • |

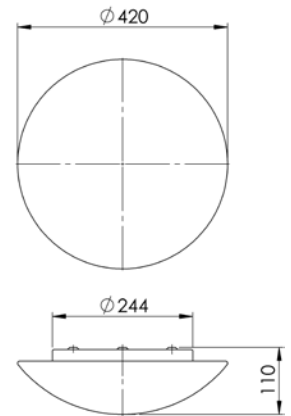

Opalglasleuchte GLANUR 310 S (E27 Fassung, Leuchtstofflampen, LED)
 Ausführung opal glänzend oder matt, Unterteil weiß, Stahl oder Aluminium (LED), mundgeblasenes Dreischichtglas Triplex mit sehr guter blendfreier Lichtverteilung, einfache und schnelle Montage mit Klappverschluss, starke Federn für sicheren Halt, für Wand- /Deckenmontage geeignet, LED Leuchten auch mit Bewegungssensor



| Opal glanz B. Nr. | Opal matt B. Nr. | Bestückung | Leistung | Montage | | Sensor | Eulum data | ENEC |
|--------------------------|---------------------|------------|----------|---------|------|--------|---------------|------|
| | | | | Decke | Wand | | | |
| E2 LEUCHTEN IP40 | | | | | | | | |
| 34100 | 34101 | 2xE27 | 2x60W | • | • | | | |
| 34110 | 34111 | 3xE27 | 3x40W | • | • | | | |
| E27 LEUCHTEN IP44 | | | | | | | | |
| 34104 | 34105 | 2xE27 | 2x60W | • | • | | | |
| 34114 | 34115 | 3xE27 | 3x40W | • | • | | | |



| Opal glanz B. Nr. | Opal matt B. Nr. | Bestückung | Leistung | Montage | | Lumens /Lichtfarbe | | | Sensor | Eulum data | ENEC | Dim |
|--------------------------|---------------------|------------|----------|---------|------|--------------------|-------|-------|--------|---------------|------|-----|
| | | | | Decke | Wand | 3000K | 4000K | 5600K | | | | |
| LED LEUCHTEN IP40 | | | | | | | | | | | | |
| 54140 | 54141 | AC LED | 17W | • | • | 1500 | 1700 | 1700 | | • | | • |
| 54142 | 54143 | AC LED | 17W | • | • | 1500 | 1700 | 1700 | • | • | | • |
| 54100 | 54101 | AC LED | 27W | • | • | 2250 | 2250 | | | | | |
| 54102 | 54103 | AC LED | 27W | • | • | 2250 | 2250 | | • | | | |
| 54110 | 54111 | AC LED | 36W | • | • | 3000 | 3000 | | | • | | |
| 54112 | 54113 | AC LED | 36W | • | • | 3000 | 3000 | | • | • | | |
| 54120 | 54121 | AC LED | 39W | • | • | 3390 | 4050 | 4050 | | • | | • |
| 54122 | 54123 | AC LED | 39W | • | • | 3390 | 4050 | 4050 | • | • | | • |
| 54160 | 54161 | AC LED | 51W | • | • | 4500 | 5100 | 5100 | | • | | • |
| 54162 | 54163 | AC LED | 51W | • | • | 4500 | 5100 | 5100 | • | • | | • |
| 54130 | 54131 | AC LED | 52W | • | • | 4520 | 5400 | 5400 | | • | | • |
| 54132 | 54132 | AC LED | 52W | • | • | 4520 | 5400 | 5400 | • | • | | • |
| LED LEUCHTEN IP44 | | | | | | | | | | | | |
| 54144 | 54145 | AC LED | 17W | • | • | 1500 | 1700 | 1700 | | • | | • |
| 54146 | 54147 | AC LED | 17W | • | • | 1500 | 1700 | 1700 | • | • | | • |
| 54104 | 54105 | AC LED | 27W | • | • | 2250 | 2250 | | | | | |
| 54106 | 54107 | AC LED | 27W | • | • | 2250 | 2250 | | • | | | |
| 54114 | 54115 | AC LED | 36W | • | • | 3000 | 3000 | | | • | | |
| 54116 | 54117 | AC LED | 36W | • | • | 3000 | 3000 | | • | • | | |
| 54124 | 54125 | AC LED | 39W | • | • | 3390 | 4050 | 4050 | | • | | • |
| 54126 | 54127 | AC LED | 39W | • | • | 3390 | 4050 | 4050 | • | • | | • |
| 54164 | 54165 | AC LED | 51W | • | • | 4500 | 5100 | 5100 | | • | | • |
| 54166 | 54167 | AC LED | 51W | • | • | 4500 | 5100 | 5100 | • | • | | • |
| 54134 | 54135 | AC LED | 52W | • | • | 4520 | 5400 | 5400 | | • | | • |
| 54136 | 54137 | AC LED | 52W | • | • | 4520 | 5400 | 5400 | • | • | | • |

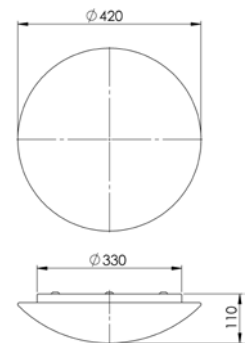

PMMA Leuchte GLANUR 290 P (Leuchtstofflampe, LED)
 Unterteil Stahl oder Aluminium (LED), für Wand- und Deckenmontage geeignet, LED Leuchten auch mit Bewegungssensor ausgestattet



| Opal glanz B. Nr. | Opal matt B. Nr. | Bestückung | Leistung | Montage | | Lumens /Lichtfarbe | | | Sensor | Eulum data | ENEC | Dim |
|--------------------------|---------------------|------------|----------|---------|------|--------------------|-------|-------|--------|---------------|------|-----|
| | | | | Decke | Wand | 3000K | 4000K | 5600K | | | | |
| LED LEUCHTEN IP40 | | | | | | | | | | | | |
| 14841 | | AC LED | 12W | • | • | 780 | | 1080 | | | | |
| 14843 | | AC LED | 16W | • | • | 1040 | | 1440 | | | | |
| 15691 | | AC LED | 16W | • | • | 1040 | | 1440 | • | | | |



| Opal glanz B. Nr. | Opal matt B. Nr. | Typ | Leistung | Bestückung | Montage | | Sensor | Eulum data | ENEC |
|-------------------------------|---------------------|-----|----------|------------|---------|------|--------|---------------|------|
| | | | | | Decke | Wand | | | |
| LEUCHTSTOFFLAMPEN IP40 | | | | | | | | | |
| 14820 | | EVG | 13W | 1xG24q1 | • | • | | | • |
| 14821 | | EVG | 18W | 1xG24q2 | • | • | | | • |

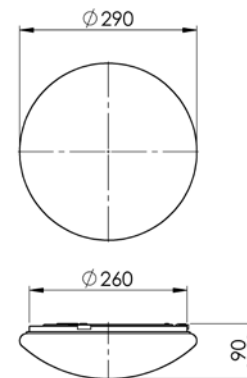

PMMA Leuchte GLANUR 290 P (Leuchtstofflampe, LED)

Unterteil Stahl oder Aluminium (LED), für Wand- / Deckenmontage geeignet, LED Leuchten auch mit Bewegungssensor ausgestattet

IP40

230V



| Opal glanz B. Nr. | Opal matt B. Nr. | Bestückung | Leistung | Montage | | Sensor | Eulum data | ENEC |
|--------------------------|---------------------|------------|----------|---------|------|--------|---------------|------|
| | | | | Decke | Wand | | | |
| E27 LEUCHTEN IP40 | | | | | | | | |
| | 33101 | 1xE27 | 40W | • | • | | | |
| | 33111 | 1xE27 | 2x25W | • | • | | | |



IP40

230V



| Opal glanz B. Nr. | Opal matt B. Nr. | Bestückung | Leistung | Montage | | Lumens /Lichtfarbe | | | Sensor | Eulum data | ENEC | Dim |
|--------------------------|---------------------|------------|----------|---------|------|--------------------|-------|-------|--------|---------------|------|-----|
| | | | | Decke | Wand | 3000K | 4000K | 5600K | | | | |
| LED LEUCHTEN IP40 | | | | | | | | | | | | |
| | 53141 | AC LED | 12W | • | • | 1120 | 1200 | | | | | |
| | 53143 | AC LED | 12W | • | • | 1120 | 1200 | | • | | | |
| | 53111 | AC LED | 13W | • | • | 1130 | 1350 | 1350 | | • | | • |
| | 53113 | AC LED | 13W | • | • | 1130 | 1350 | 1350 | • | • | | • |
| | 53121 | AC LED | 17W | • | • | 1500 | 1700 | 1700 | | • | | • |
| | 53123 | AC LED | 17W | • | • | 1500 | 1700 | 1700 | • | • | | • |
| | 53131 | AC LED | 27W | • | • | 2145 | 2250 | | | • | | |
| | 53133 | AC LED | 27W | • | • | 2145 | 2250 | | • | • | | |

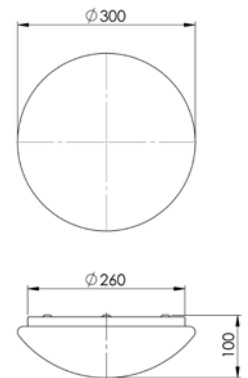

IP40

230V



| Opal glanz B. Nr. | Opal matt B. Nr. | Typ | Leistung | Bestückung | Montage | | Sensor | Eulum data | ENEC |
|-------------------------------|---------------------|-----|----------|------------|---------|------|--------|---------------|------|
| | | | | | Decke | Wand | | | |
| LEUCHTSTOFFLAMPEN IP40 | | | | | | | | | |
| | 43101 | EVG | 13W | 1xG24q1 | • | • | | | |
| | 43121 | EVG | 18W | 1xG24q2 | • | • | | | |

PMMA Leuchte GLANUR 290 P (Leuchtstofflampe, LED)

Unterteil Stahl oder Aluminium (LED), für Wand- / Deckenmontage geeignet, LED Leuchten auch mit Bewegungssensor ausgestattet



| Opal glanz B. Nr. | Opal matt B. Nr. | Bestückung | Leistung | Montage | | Sensor | Eulum data | ENEC |
|--------------------------|---------------------|------------|----------|---------|------|--------|---------------|------|
| | | | | Decke | Wand | | | |
| E27 LEUCHTEN IP40 | | | | | | | | |
| 33200 | | 1xE27 | 40W | • | • | | | |
| 33210 | | 1xE27 | 2x25W | • | • | | | |



| Opal glanz B. Nr. | Opal matt B. Nr. | Bestückung | Leistung | Montage | | | Lumens /Lichtfarbe | | | Sensor | Eulum data | ENEC | Dim |
|--------------------------|---------------------|------------|----------|---------|------|--|--------------------|-------|-------|--------|---------------|------|-----|
| | | | | Decke | Wand | | 3000K | 4000K | 5600K | | | | |
| LED LEUCHTEN IP40 | | | | | | | | | | | | | |
| 53240 | | AC LED | 12W | • | • | | 1120 | 1200 | | | | | |
| 53242 | | AC LED | 12W | • | • | | 1120 | 1200 | | • | | | |
| 53210 | | AC LED | 13W | • | • | | 1130 | 1350 | 1350 | | • | | • |
| 53212 | | AC LED | 13W | • | • | | 1130 | 1350 | 1350 | • | • | | • |
| 53220 | | AC LED | 17W | • | • | | 1500 | 1700 | 1700 | | • | | • |
| 53222 | | AC LED | 17W | • | • | | 1500 | 1700 | 1700 | • | • | | • |
| 53230 | | AC LED | 27W | • | • | | 2145 | 2250 | | | • | | |
| 53232 | | AC LED | 27W | • | • | | 2145 | 2250 | | • | • | | |

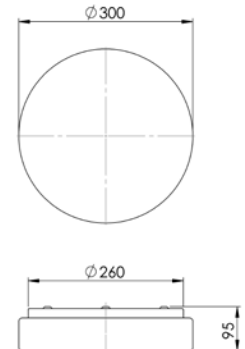

| Opal glanz B. Nr. | Opal matt B. Nr. | Typ | Leistung | Bestückung | Montage | | Sensor | Eulum data | ENEC |
|-------------------------------|---------------------|-----|----------|------------|---------|------|--------|---------------|------|
| | | | | | Decke | Wand | | | |
| LEUCHTSTOFFLAMPEN IP40 | | | | | | | | | |
| 43200 | | EVG | 13W | 1xG24q1 | • | • | | | |
| 43220 | | EVG | 18W | 1xG24q2 | • | • | | | |

PMMA Leuchte GLANUR 370 PF (Leuchtstofflampe, LED)

Unterteil Metall weiß mit Halterung aus Stahl, für Wand- und Deckenmontage geeignet, LED Leuchten mit Bewegungssensor ausstattbar



| Opal glanz B. Nr. | Opal matt B. Nr. | Bestückung | Leistung | Montage | | Lumens /Lichtfarbe | | | Sensor | Eulum data | ENEC | Dim |
|--------------------------|---------------------|------------|----------|---------|------|--------------------|-------|-------|--------|---------------|------|-----|
| | | | | Decke | Wand | 3000K | 4000K | 5600K | | | | |
| LED LEUCHTEN IP40 | | | | | | | | | | | | |
| | 14842 | AC LED | 12W | • | • | 780 | | 1080 | | | | |
| | 14844 | AC LED | 16W | • | • | 1040 | | 1440 | | | | |
| | 15693 | AC LED | 16W | • | • | 1040 | | 1440 | • | | | |



| Opal glanz B. Nr. | Opal matt B. Nr. | Typ | Leistung | Bestückung | Montage | | Sensor | Eulum data | ENEC |
|-------------------------------|---------------------|-----|----------|------------|---------|------|--------|---------------|------|
| | | | | | Decke | Wand | | | |
| LEUCHTSTOFFLAMPEN IP40 | | | | | | | | | |
| | 14831 | EVG | 18W | 1xG24q2 | • | • | | | • |
| | 14832 | EVG | 26W | 1xG24q3 | • | • | | | • |
| | 14834 | EVG | 2x18W | 2xG24q2 | • | • | | | |

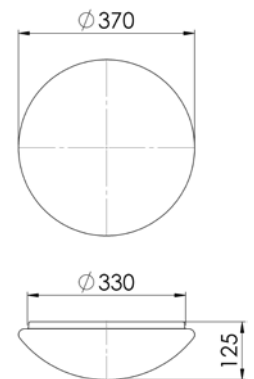

PMMA Leuchte GLANUR 370 PPF (Leuchtstofflampe, LED)
 Unterteil Metall weiß mit Halterung aus Stahl, für Wand- und Deckenmontage geeignet, LED Leuchten mit Bewegungssensor ausstattbar



| Opal glanz B. Nr. | Opal matt B. Nr. | Bestückung | Leistung | Montage | | Lumens /Lichtfarbe | | | Sensor | Eulum data | ENEC | Dim |
|--------------------------|---------------------|------------|----------|---------|------|--------------------|-------|-------|--------|---------------|------|-----|
| | | | | Decke | Wand | 3000K | 4000K | 5600K | | | | |
| LED LEUCHTEN IP40 | | | | | | | | | | | | |
| 16800 | | AC LED | 12W | • | • | 780 | | 1080 | | | | |
| 16801 | | AC LED | 16W | • | • | 1040 | | 1440 | | | | |
| 16802 | | AC LED | 16W | • | • | 1040 | | 1440 | • | | | |



| Opal glanz B. Nr. | Opal matt B. Nr. | Typ | Leistung | Bestückung | Montage | | Sensor | Eulum data | ENEC |
|-------------------------------|---------------------|-----|----------|------------|---------|------|--------|---------------|------|
| | | | | | Decke | Wand | | | |
| LEUCHTSTOFFLAMPEN IP40 | | | | | | | | | |
| 16811 | | EVG | 18W | 1xG24q2 | • | • | | | • |
| 16812 | | EVG | 26W | 1xG24q3 | • | • | | | • |
| 16814 | | EVG | 2x18W | 2xG24q2 | • | • | | | |

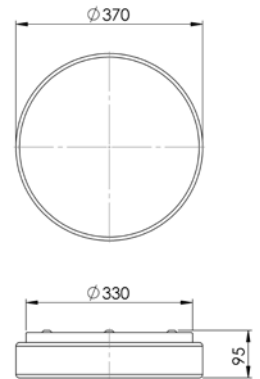

PMMA Leuchte GLANUR 370 P (E27 Lampen, Leuchtstofflampen, LED)
 Unterteil weiß, Stahl oder Aluminium (LED), einfache und schnelle Montage Dank Klappverschluss mit starken Federn, für Wand- /Deckenmontage geeignet, LED Leuchten mit Bewegungssensor ausstattbar



| Opal glanz B. Nr. | Opal matt B. Nr. | Bestückung | Leistung | Montage | | Sensor | Eulum data | ENEC |
|--------------------------|---------------------|------------|----------|---------|------|--------|---------------|------|
| | | | | Decke | Wand | | | |
| E27 LEUCHTEN IP40 | | | | | | | | |
| | 34201 | 2xE27 | 2x25W | • | • | | | |
| | 34211 | 3xE27 | 3x25W | • | • | | | |



| Opal glanz B. Nr. | Opal matt B. Nr. | Bestückung | Leistung | Montage | | Lumens /Lichtfarbe | | | Sensor | Eulum data | ENEC | Dim |
|--------------------------|---------------------|------------|----------|---------|------|--------------------|-------|-------|--------|---------------|------|-----|
| | | | | Decke | Wand | 3000K | 4000K | 5600K | | | | |
| LED LEUCHTEN IP40 | | | | | | | | | | | | |
| | 54241 | AC LED | 17W | • | • | 1500 | 1700 | 1700 | | • | | • |
| | 54243 | AC LED | 17W | • | • | 1500 | 1700 | 1700 | • | • | | • |
| | 54201 | AC LED | 27W | • | • | 2145 | 2250 | | | | | |
| | 54203 | AC LED | 27W | • | • | 2145 | 2250 | | • | | | |
| | 54211 | AC LED | 36W | • | • | 2860 | 3000 | | | • | | |
| | 54213 | AC LED | 36W | • | • | 2860 | 3000 | | • | • | | |
| | 54221 | AC LED | 39W | • | • | 3390 | 4050 | 4050 | | • | | • |
| | 54223 | AC LED | 39W | • | • | 3390 | 4050 | 4050 | • | • | | • |
| | 54261 | AC LED | 51W | • | • | 4500 | 5100 | 5100 | | • | | • |
| | 54263 | AC LED | 51W | • | • | 4500 | 5100 | 5100 | • | • | | • |
| | 54231 | AC LED | 52W | • | • | 4520 | 5400 | 5400 | | • | | • |
| | 54233 | AC LED | 52W | • | • | 4520 | 5400 | 5400 | • | • | | • |

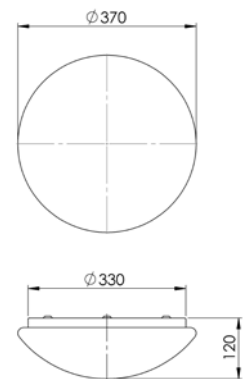

| Opal glanz B. Nr. | Opal matt B. Nr. | Typ | Leistung | Bestückung | Montage | | Sensor | Eulum data | ENEC |
|-------------------------------|---------------------|-----|----------|------------|---------|------|--------|---------------|------|
| | | | | | Decke | Wand | | | |
| LEUCHTSTOFFLAMPEN IP40 | | | | | | | | | |
| | 44221 | EVG | 18W | 1xG24q2 | • | • | | | • |
| | 44241 | EVG | 26W | 1xG24q3 | • | • | | | • |

PMMA Leuchte GLANUR 370 PP (E27 Lampen, Leuchtstofflampen, LED)
 Unterteil weiß, Stahl oder Aluminium (LED), einfache und schnelle Montage Dank Klappverschluss mit starken Federn, für Wand- /Deckenmontage geeignet, LED Leuchten mit Bewegungssensor ausstattbar



| Opal glanz B. Nr. | Opal matt B. Nr. | Bestückung | Leistung | Montage | | Sensor | Eulum data | ENEC |
|--------------------------|---------------------|------------|----------|---------|------|--------|---------------|------|
| | | | | Decke | Wand | | | |
| E27 LEUCHTEN IP40 | | | | | | | | |
| 34300 | | 2xE27 | 2x25W | • | • | | | |
| 34310 | | 3xE27 | 3x25W | • | • | | | |



| Opal glanz B. Nr. | Opal matt B. Nr. | Bestückung | Leistung | Montage | | Lumens /Lichtfarbe | | | Sensor | Eulum data | ENEC | Dim |
|--------------------------|---------------------|------------|----------|---------|------|--------------------|-------|-------|--------|---------------|------|-----|
| | | | | Decke | Wand | 3000K | 4000K | 5600K | | | | |
| LED LEUCHTEN IP40 | | | | | | | | | | | | |
| 54340 | | AC LED | 17W | • | • | 1500 | 1700 | 1700 | | • | | • |
| 54342 | | AC LED | 17W | • | • | 1500 | 1700 | 1700 | • | • | | • |
| 54300 | | AC LED | 27W | • | • | 2250 | 2250 | | | | | |
| 54302 | | AC LED | 27W | • | • | 2250 | 2250 | | • | | | |
| 54310 | | AC LED | 36W | • | • | 2860 | 3000 | | | • | | |
| 54312 | | AC LED | 36W | • | • | 2860 | 3000 | | • | • | | |
| 54320 | | AC LED | 39W | • | • | 3390 | 4050 | 4050 | | • | | • |
| 54322 | | AC LED | 39W | • | • | 3390 | 4050 | 4050 | • | • | | • |
| 54360 | | AC LED | 51W | • | • | 4500 | 5100 | 5100 | | • | | • |
| 54362 | | AC LED | 51W | • | • | 4500 | 5100 | 5100 | • | • | | • |
| 54330 | | AC LED | 52W | • | • | 4520 | 5400 | 5400 | | • | | • |
| 54332 | | AC LED | 52W | • | • | 4520 | 5400 | 5400 | • | • | | • |

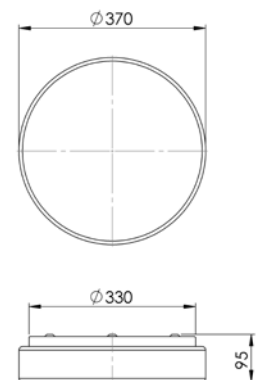

| Opal glanz B. Nr. | Opal matt B. Nr. | Typ | Leistung | Bestückung | Montage | | Sensor | Eulum data | ENEC |
|-------------------------------|---------------------|-----|----------|------------|---------|------|--------|---------------|------|
| | | | | | Decke | Wand | | | |
| LEUCHTSTOFFLAMPEN IP40 | | | | | | | | | |
| | 44320 | EVG | 18W | 1xG24q2 | • | • | | | • |
| | 44340 | EVG | 26W | 1xG24q3 | • | • | | | • |

**Impressum:
METAJ EPU
Hauptstraße 10/1
2602 Blumau-Neurißhof
Tel.Nr.: 0676/575 09 52**

METAJ

■ ARCHITECTURE & DESIGN
▼ TECHNOLOGY & INDUSTRY
● PROJECT ENGINEERING